



### PRODUCT DETAILS

The BiANCO NXT MULTI-SP is the perfect solution whether you need to boost water pressure. Compact, quiet and efficient, the MULTI-SP is a 'self-priming' booster pump, able to draw water up into the pump from shallow wells or submerged tanks. Supplied prewired with the award-winning BiANCO NXT PRO controller, the user can choose between pump operating modes making MULTI-SP the perfect solution for domestic household supply, water transfer or light irrigation / horticultural use in rural and semi-rural applications.

### APPLICATIONS

- Household water supply
- Pressure boosting
- Light commercial applications
- Water transfer
- Washing systems
- Light Irrigation

### FEATURES

- Pre-wired, dual mode, auto-restart pump controller
- Digital display
- Dry-run, frequent start, maximum run time protection
- Built from high quality materials
- Self priming operation

### TECHNICAL DATA

<b>OUTPUT POWER (KW)</b>	1.0kW P2
<b>MAX. HEAD [M]</b>	72M
<b>MAX. FLOW L/MIN</b>	98 l/min
<b>MAX PRESSURE</b>	Pump: 8 bar Controller 10 bar
<b>LIQUID TEMPERATURE</b>	2 - 40 deg C
<b>MOTOR</b>	Asynchronous TEFC
<b>MOTOR INSULATION</b>	F Class insulation
<b>MOTOR PROTECTION</b>	In-built thermal overload
<b>PROTECTION CLASS</b>	IP45
<b>PRESSURE TANK</b>	0.3 litre controller volume 3, 8 or 18 litre recommended

<b>RATED VOLTAGE</b>	220 - 240V 1Ph 50 Hz
<b>RATED CURRENT</b>	5.8A
<b>CAPACITOR</b>	25uF 450V
<b>POWER CABLE</b>	1.2m long 10 amp rated H05 flex 10 amp 3 pin plug
<b>AUTOMATIC OPERATION</b>	Yes - Dual mode NXT PRO
<b>PUMP BODY</b>	Stainless steel
<b>INTERNALS</b>	Composite impeller / diffusers
<b>MECHANICAL SEAL</b>	Silicon Carbide/Carbon
<b>PACKAGE DIMENSION</b>	460 x 230 x 420
<b>GROSS WEIGHT (KG)</b>	16kg

Fitment of an additional pressure tank is mandatory when the controller is set to MODE 2 (Digital Pressure Switch)

## CURVE

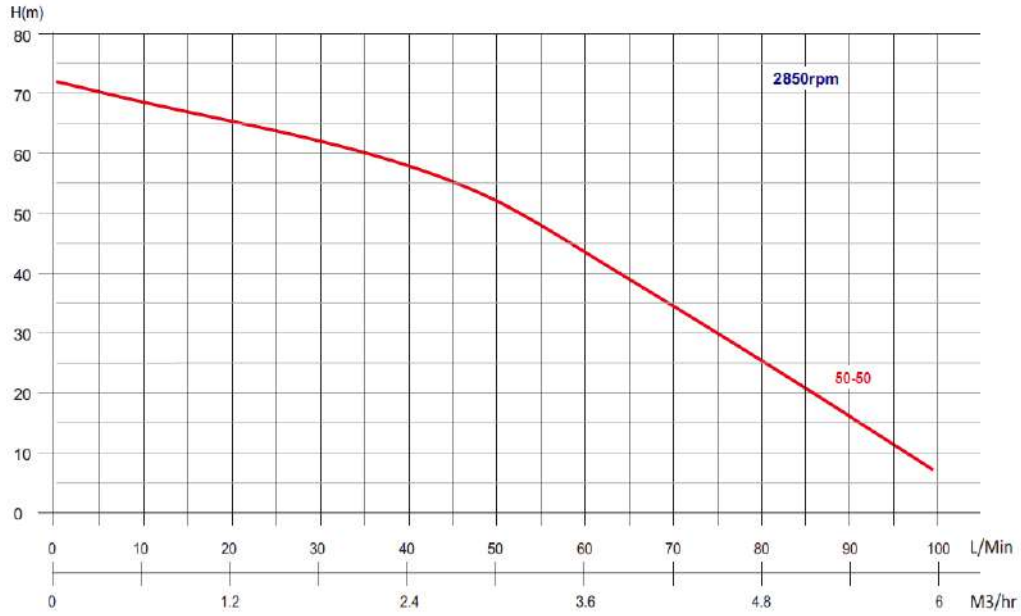

## DIMENSIONS

### HEIGHT WITH CONTROLLER FITTED

402mm

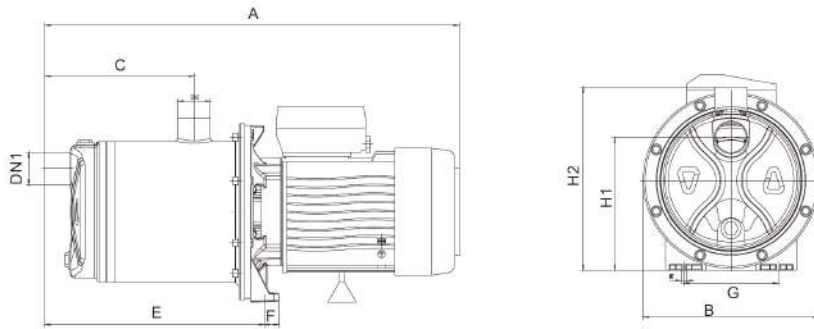

A	B	C	E	F	G	I	H1	H2	Dn1	Dn2
460.5	195.5	166	244	16	110	9	148	204	G1"	G1"

## WARRANTY / CERTIFICATIONS

